

Calmbee

USA

Induction Hob

Instruction Manual / Installation Manual

MODEL: FTS235G3HWP-78CM

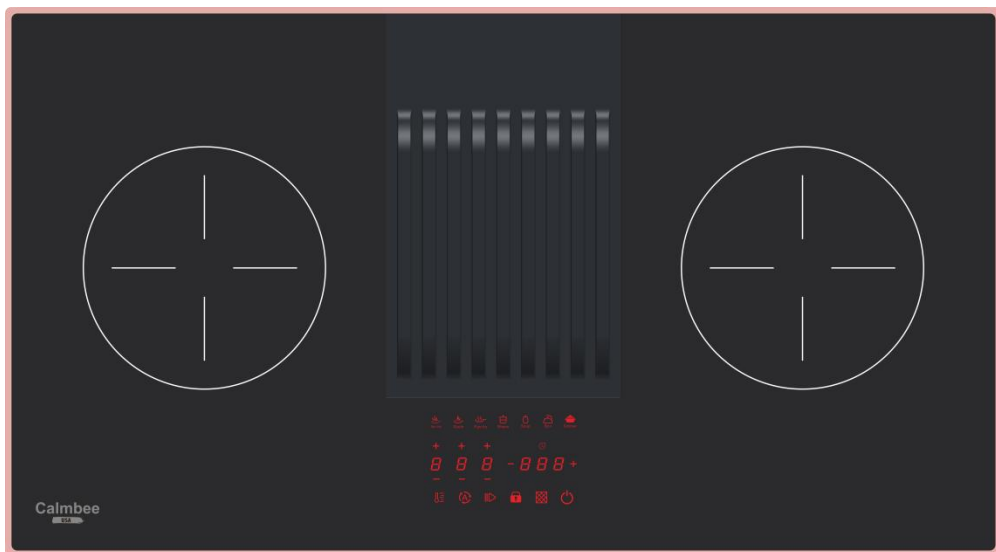



Safety Warnings

Your safety is important to us. Please read this information before using your cooktop.

- ✓ The appliance is not to be used by persons (including children) with reduced physical, sensory or mental capabilities, or lack of experience and knowledge, unless they have been given supervision or instruction. children being supervised not to play with the appliance.
- ✓ Warning: If the surface is cracked, switch off the appliance to avoid the possibility of electric shock, for hob surfaces of glass-ceramic or similar material which protect live parts.
- ✓ Warning: a steam cleaner is not be used.
- ✓ Metallic objects such as knives, forks, spoons and lids should not be placed on the hob surface since they can get hot.
- ✓ After use, switch off the hob element by its control and do not rely on the pan detector. The appliance is not intended to be operated by means of external timer or separated remote-control system.
- ✓ Danger of fire: Do not store items on the cooking surfaces.
- ✓ CAUTION: The cooking process has to be supervised. A short term cooking process has to be supervised continuously.

- ✓ **WARNING:** Unattended cooking on a hob with fat or oil can be dangerous and may result in a fire.
- ✓ If the supply cord is damaged, it must be replaced by the manufacturer, its service agent or similarly qualified persons in order to avoid a hazard.
- ✓ This appliance can be used by children aged from 8 years and above and persons with reduced physical, sensory or mental capabilities or lack of experience and knowledge if they have been given supervision or instruction concerning use of the appliance in a safe way and understand the hazards involved. children shall not play with the appliance. cleaning and user maintenance shall not be made by children without supervision.
- ✓ **WARNING:** The appliance and its accessible parts become hot during use.
- ✓ Care should be taken to avoid touching heating elements.
- ✓ Children less than 8 years of age shall be kept away unless continuously supervised.
- ✓ **WARNING:** Unattended cooking on a hob with fat or oil can be dangerous and may result in fire.

- ✓ Never try to extinguish a fire with water, but switch off the appliance and then cover flame
e.g. with a lid or a fire blanket.
- ✓ CAUTION: The cooking process has to be supervised. A short term cooking process has to be supervised continuously.
- ✓ WARNING: Danger of fire: do not store items on the cooking surfaces.
- ✓ WARNING: Use only hob guards designed by the manufacturer of the cooking appliance or indicated by the manufacturer of the appliance in the instructions for use as suitable or hob guards incorporated in the appliance. The use of inappropriate guards can cause accidents.
- ✓ Power cord can't accessible after installation.

Congratulations on the purchase of your new Induction Hob.

We recommend that you spend some time to read this Instruction / Installation Manual in order to fully understand how to install correctly and operate it.

For installation, please read the installation section.

Read all the safety instructions carefully before use and keep this Instruction / Installation Manual for future reference.





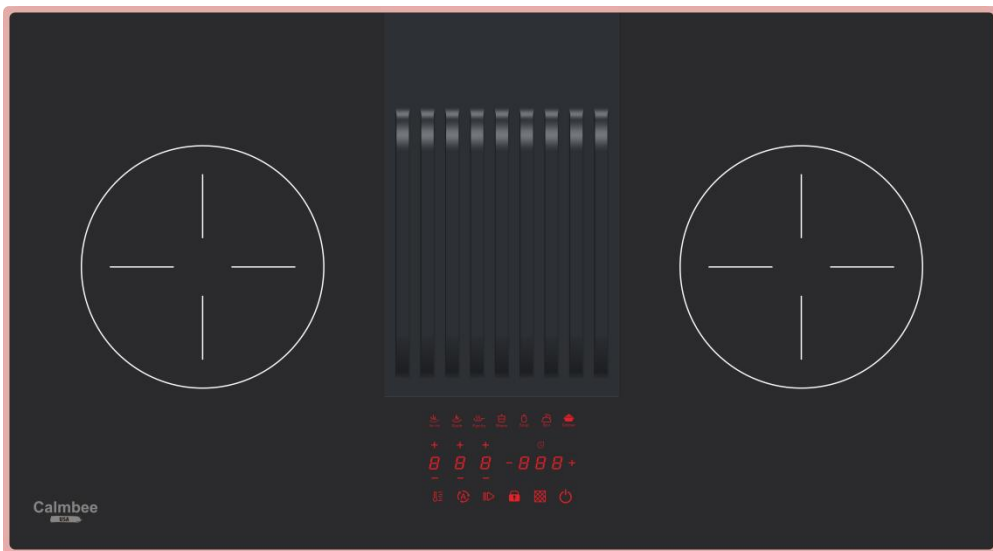



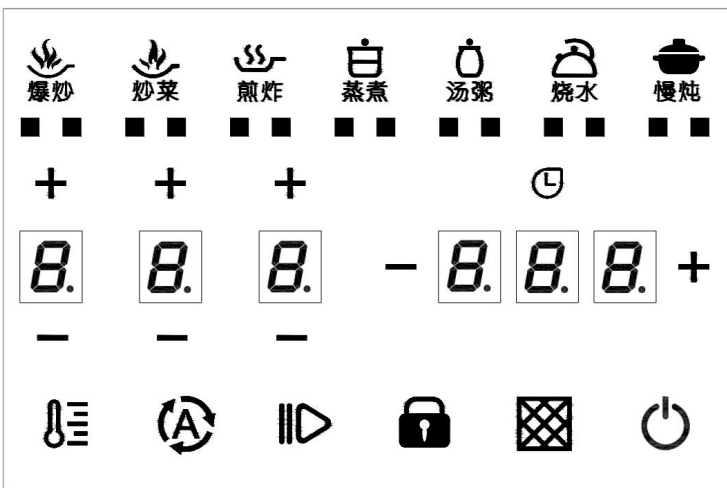

Product Overview

Top View



User interface



Reference	Description
A 	ON/OFF key
B 	Zone select key and power regulating key
C 	Child lock key
D 	Pause key
E 	Keep warm key
F 	Auto Hood key
G 	Timer select key
H 	Timer regulating key
I 	Filter reset key
J 	Cooking mode select key

Power consumption

Heating Zone	Max.Power (220-240V~ 50/60Hz)
Left zone	2300/2600W (Booster)
Right zone	2300/2600W (Booster)
Cooker hood	160W,750-800m ³ /h air-flow
Total Rating Power	3500W

A Word on Induction Cooking

Induction cooking is a safe, advanced, efficient, and economical cooking technology. It works by electromagnetic vibrations generating heat directly in the pan, rather than indirectly through heating the glass surface. The glass becomes hot only because the pan eventually warms it up.

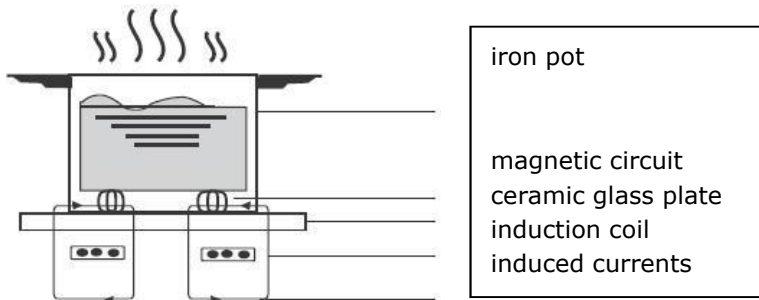

Before using your new induction hob

- Read this guide, taking special note of the 'Safety Warnings' section.
- Remove any protective film that may still be on your Induction hob.

Using the touch Controls

- The controls respond to touch, so you don't need to apply any pressure.
- Use the ball of your finger, not its tip.
- You will hear a beep each time a touch is registered.
- Make sure the controls are always clean, dry, and that there is no object (e.g. a utensil or a cloth) covering them. Even a thin film of water may make the controls difficult to operate.

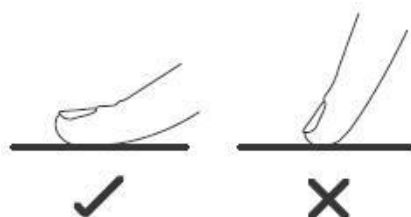

Choosing the right cookware



- Only use cookware with a base suitable for induction cooking. Look for the induction symbol on the packaging or on the bottom of the pan.
- You can check whether your cookware is suitable by carrying out a magnet test. Move a magnet towards the base of the pan. If it is attracted, the pan is suitable for induction.
- If you do not have a magnet:
 1. Put some water in the pan you want to check.
 2. If  does not flash in the display and the water is heating, the pan is suitable.
- Cookware made from the following materials is not suitable: pure stainless steel, aluminum or copper without a magnetic base, glass, wood, porcelain, ceramic, and earthenware.

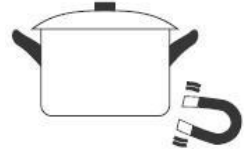

Do not use cookware with jagged edges or a curved base.



Make sure that the base of your pan is smooth, sits flat against the glass, and is the same size as the cooking zone. Use pans whose diameter is as large as the graphic of the zone selected. Using a pot a slightly wider energy will be used at its maximum efficiency. If you use smaller pot efficiency could be less than expected. Pot less than 140 mm could be undetected by the hob. Always centre your pan on the cooking zone.

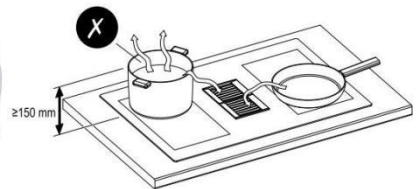
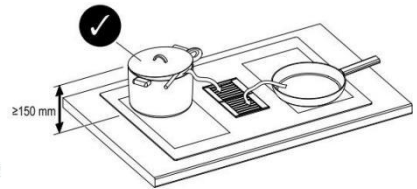
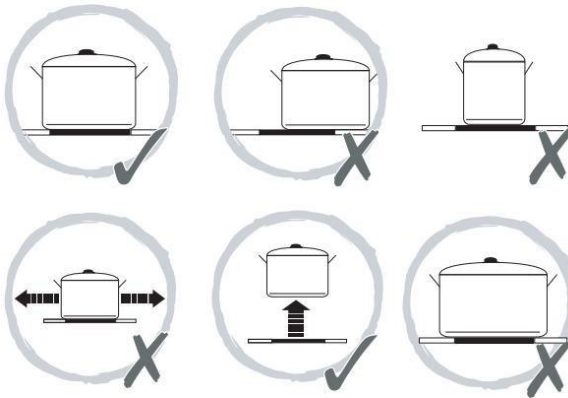

IMPORTANT: Always lift pans off the cooking surface!
Do not slide or drag to avoid damaging the glass.
Use a lid that is slightly ajar if using cookware taller than 150mm.

Using your induction hob

To start cooking

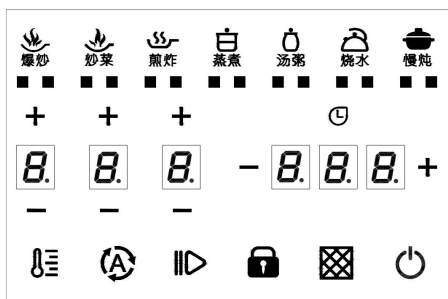

1. Touch the ON/OFF key  for 2 seconds.
After power on, the buzzer beeps once, all displays show " - " or "0", indicating that the induction hob has entered the state of standby mode.
 2. Place a suitable pan on the cooking zone that you want to use.
 - Make sure the bottom of the pan and the surface of the cooking zone are clean and dry.
 3. According to the heating zone where the pan is placed, select a relevant zone by pressing key(B), the symbol 0. selected will stay fully.
 4. Adjust the power level by touching the regulating key **+** or **-** control.
Touch key **+** for first setting will start at level 5; Touch key **-** for first setting will start at level 9.
Pressing the **+** will count up the power from 0-9 level; Pressing the **-** will count down the power circularly.
Touch the **+** and **-** together to adjust the power continuously.
- If you don't choose a power setting within 1 minute, the induction hob will automatically switch off. You will need to start again at step 1.
 - You can modify the power setting at any time during cooking.

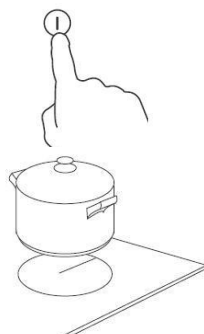

If the display flashes alternately with the power setting

This means that:

- You have not placed a pan on the correct cooking zone or,
 - The pan you're using is not suitable for induction cooking or,
 - The pan is too small or not properly centered on the cooking zone.
- No heating takes place unless there is a suitable pan on the cooking zone.
The display will automatically turn off after 1 minutes if no suitable pan placed on it or no any other operation.

When you have finished cooking

- 1.Touching the relevant zone select key(B) that you want to switch off.
- 2.Press the regulating key to decrease the power to "0" level, and the heating will stop.
- 3.Beware of hot surfaces indicator light "H" will show which cooking zone is hot to touch. It will disappear when the surface has cooled down to a safe temperature. It can also be used as an energy saving function if you want to heat further pans, use the hotplate that is still hot.

Using the Boost function

Active boost function





1. Select the heating zone by touching the zone select key (B).
2. Touching the regulating key to adjust the power to P , the zone indicator show "P" and the power reach Max.

Cancel the Boost function

- 1.Touching the relevant zone select key(B) that you want to cancel.
 - 2.Touching the regulating key to cancel the Boost function, then the cooking zone will revert to the power level you wish.
- The function can work in any cooking zone.
 - The cooking zone returns to level 9 after 5 minutes.

Using the Keep warm Function

1. Touch the cooking zone selection button that you want to use Keep Warm.

Touch the relevant keep warm key(E) , the cooking zone indicator will display “” “” “”.

2. Touch the button key(E) ‘’ to choose three level keep warm heating.

“” -Melt or defrost (about 50°C)



“” -Heating or keeping warm (about 70°C)

“” -Simmering , temperature close to boiling ,useful for slow cooking

3. If you want to cancel the keep warm, select the cooking zone you want to operate, touch the regulating key, The keep warm function will be off.

Using the Pause Function

The hob have a handy restart function to pause and restart the cooking process if you’ re interrupted.

1. When the hob is on and working, press the pause key(D)  and hold for 1 second, all burner will stop working, and all burner LED indicators will show the symbol “”

2. At pause mode, if there is no operation after 10 minutes, it will automatically shut down.

3. Touch the pause key(D)  and hold for 1 second again, all setting will restart at the previous setting.

Using Child Lock Function

- You can lock the controls to prevent unintended use (for example children accidentally turning the cooking zones on).
- When the controls are locked, all the controls except the OFF control are disabled.

To lock the controls

Touch the child lock key and hold for 2 seconds, the button will high light display. The button will flash for 5 seconds if touching other keys at lock mode.

To unlock the controls

1. Make sure the Induction hob is turned on. Touch the child lock key and hold for 2 seconds.
2. You can now start using your Induction hob.



When the hob is in the lock mode, all the controls are disable except OFF , you can always turn the hob off with the OFF control in an emergency, but you shall unlock the hob first in the next operation .

Over-Temperature Protection

A temperature sensor equipped can monitor the temperature inside the Induction hob. When an excessive temperature is monitored, the Induction hob will stop operation automatically.

Detection of Small Articles

When an unsuitable size or non-magnetic pan (e.g. aluminium), or some other small item (e.g. knife, fork, key) has been left on the hob, the hob automatically go on to standby in 1 minute. The fan will keep cooling down the induction hob for a further 1 minute.

Auto Shutdown Protection

Auto shut down is a safety protection function for your induction hob. It shut down automatically if ever you forget to turn off your cooking. The default working times for various power levels are shown in the below table:

Power level	1~3	4~6	7~8	9
Default working timer (min)	360	180	120	90







When the pot is removed, the induction hob can stop heating immediately and the hob automatically switch off after 2 minutes.



People with a heart pace maker should consult with their doctor before using this unit.

Using the Cooking mode

1. Touch the cooking zone selection button that you want to select cooking mode.
2. Touch the button of cooking mode for choosing.

	Stir-fry The power will reach 2600W (P level) for 5 minutes. The power will return to 9 level after 5 minutes for cooking.
	Saute The power will reach 2300W (9 level) for cooking.
	Pan-fry The power will reach 2300W (9 level) for 10 minutes. Then, it will return to 1500W (8 level) for cooking.
	Steam The power will reach 2300W (9 level) for 6 minutes. Then, it will return to 1200w (7 level) for 24 minutes. Note: the timer will set 30 minutes for this mode, but you can reset the time you want.
	Soup The power will reach 2300W (9 level) for 4 minutes. Then, it will return to 1200w (7 level) for 15 minutes. Then, it will return to 300w for 111 minutes. Note: the timer will set 120 minutes for this mode, but you can reset the time you want. When the cooking time expired, it will active keep warm level 1 for 120 minutes.
	Boil The power will reach 2300W (9 level) for 11 minutes. Then, it will return to 600w for 10 minutes.
	Simmer The power will reach 250W (4 level) for 120 minutes. Note: the timer will set 120 minutes for this mode, but you can reset the time you want.

Using the Timer

You can use the timer in two different ways:





- You can use it as a minute minder. In this case, the timer will not turn any cooking zone off when the set time is up.
- You can set it to turn one cooking zone off after the set time is up.
- You can set the timer for up to 120 minutes.

Using the Timer as a Minute Minder

If you are not selecting any cooking zone

1. Make sure the cooktop is turned on.



Note: you can use the minute minder even if you're not selecting any cooking zone.

2. Touch the Timer key(G) . The timer indicator will start flashing "0", and you can set the timer at this point. Touch the Timer regulating key(H) –    + to set the alarm timer.
3. Set the time by touching the "-" or "+" control of the timer. you can realize the setting of timing from 1 to 119 minutes.
4. When the time is set, it will begin to count down immediately. The display will show the remaining time .
5. Buzzer will bips for 30 seconds and the timer indicator will turn off when the setting time finished.

Note: Touch the Timer key(G)  and hold for 2 seconds to cancel the minute minder time.

Setting the timer to turn one or more cooking zones off

If the timer is set on one zone:

1. Select the relevant cooking zone which is working by touching the zone select key (B).
2. When the relevant cooking zone key is high light ,pressing the Timer key(G)  , the timing indicator flashes, and you can set the timer at this point.Touch the Timer regulating key(H) -  + to set the timer.
3. Using the "+" and "-" buttons, you can realize the setting of timing from 1 to 119 minutes.
4. When the time is set, it will begin to count down immediately. The display will show the remaining time.

NOTE: The red dot next to power level indicator will illuminate indicating that zone is selected.



5. When cooking timer expires, the corresponding cooking zone will be switch off automatically. Other cooking zone will keep operating if they are turned on previously.

Note: Touch the Timer key(G)  and hold for 2 seconds to cancel the time.

6. when using "the timer as an alarm" and "the timer to switch off the zones " together , the display will show the remaining time of alarm as first priority. Press cooking zone to show the remaining time of switch off timer.

Failure Display and Inspection

If an abnormality comes up, the induction hob will enter the protective state automatically and display corresponding protective codes:

Error Message	Possible Cause	What to do
	No pot or pot not suitable;	Replace the pot;
ER03	Water or pot on the glass over the control	Clean the user interface
F1E	The connection between the display board and the left mainboard is fail (the cooking zone which indicator showing "E")	1.Connection cable not correctly plugged or defective; 2.Replace the Mainboard.
F3E	Coil temperature sensor failure. (the cooking zone which indicator showing "E")	Replace the coil sensor
F4E	Mainboard temperature sensor failure. (the cooking zone which indicator showing "E")	Replace the mainboard
E1E	Temperature sensor of the ceramic glass plate is high	Please restart after the induction hob cools down.
E2 E	Temperature sensor of the IGBT is high	Please restart after the induction hob cools down.
E3 E	Abnormal supply voltage(too high)	Please inspect whether power supply is normal; Power on after the power supply is normal.
E4 E	Abnormal supply voltage (too low)	Please inspect whether power supply is normal; Power on after the power supply is normal.
E5 E	Temperature sensor failure(the cooking zone which indicator showing "E")	Connection cable not correctly plugged or assemble defective;



The above are the judgment and inspection of common failures.

Please do not disassemble the unit by yourself to avoid any dangers and damages to the induction hob and **please contact the service department.**

Using your Cooker Hood

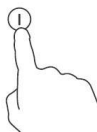
1. Touch the ON/OFF key (A)  for 3 seconds. After power on, the buzzer beeps once, all displays show " - "or "0", indicating that the cooker hood has entered the state of standby mode.



2. Select the Hood key (B)  and adjust the hood level by touching the regulating key  and key . The hood level can be selected from 0-P level.

3. P level will return to level 4 after 5 mins.

- If you don't choose a heat setting within 1 minute, the cooker hood will automatically switch off. You will need to start again at step 1.
- You can modify the setting at any time during cooking.

Using the Auto hood function

1. Under the condition of the whole machine running, touch the auto hood key (F)  to active the auto hood function, the button will high light.





2. The working speed of the Cooker hood is automatically adjusted according to the power level of the induction cooker.

Speed level of hood	Power level of Hob
Speed 1	$1 \leq \text{Total hob power level} \leq 5$ For example, zone 1 is on 2, and zone 2 is on 2.
Speed 2	$6 \leq \text{Total hob power level} \leq 11$ For example, zone 1 is on 5, zone 2 is on 5.
Speed 3	$12 \leq \text{Total hob power level} \leq 15$ For example, zone 1 is on 6, zone 2 is on 6.
Speed 4	$16 \leq \text{Total hob power level} \leq P$ For example, zone 1 is on 8, zone 2 is on P.

3. In the Cooker Hood of automatic mode, touch the key (F)  to quit the mode.

The button will half light and the hood level return to the current working level.

Use the Filter setting

1. Touch the hood key(L) .
2. Press the Filter setting key(M) Hood and hold for 6 seconds, the buzzer beeps once, indicate we can set the filter. The indicator display  or  alternately.
3. Touch the hood key(L)  to choose the filter, F for activated carbon filter, G for grease filter.
4. Press the Filter setting key(M) Hood and hold for 2 seconds for saving the setting.

Using the Filter reset function

Press the Filter reset key(I)  and hold for 3 seconds to reset the timer.

Care and maintenance



Warning

Always switch off the electricity supply before performing maintenance work. In the event of a fault, contact customer services.

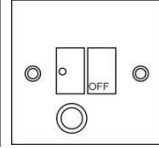

Damaged power cables should be replaced by a competent person or qualified electrician.



For domestic use only.



Never place an empty pan on the hob as this will cause an error message to appear on the control panel.



When a cooking zone has been on for a long time, the surface remains hot for some time afterwards so do not touch the ceramic surface.



For sealed foods, please do not heat them before opening removing the lid so as to avoid any dangers of explosion due to heating expansion.



If the surface of the hob is cracked, disconnect from power supply to avoid any possibility of electric shocks.



Do not place rough or uneven pans on the hob, as they could damage the ceramic surface.



Avoid banging pots and pans down on the hob. The ceramic surface is tough but not unbreakable.



Do not put detergents or flammable materials beneath the hob.

Installation

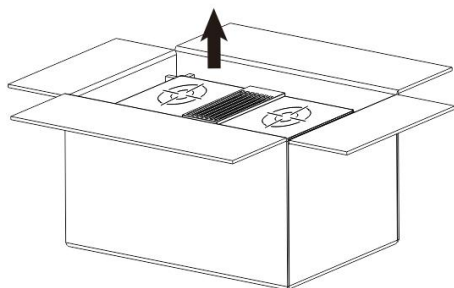

01*1



02*1



03*1



04*1

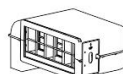

05*1



06*3



07*1



08*1



09*1

Selection of installation equipment

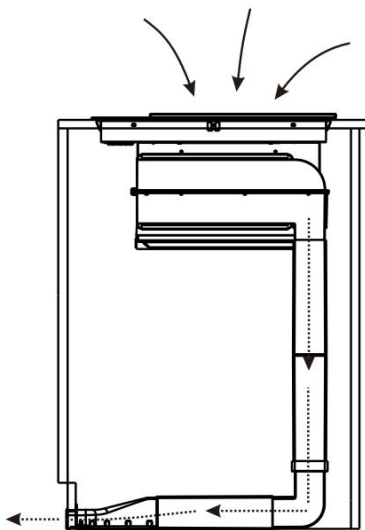
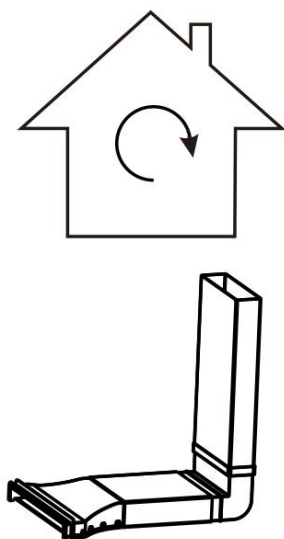

Choose a type of installation:

Recirculation option (no extraction to the outside). This appliance is for installation in a 245mm or 490mm base cabinet only.

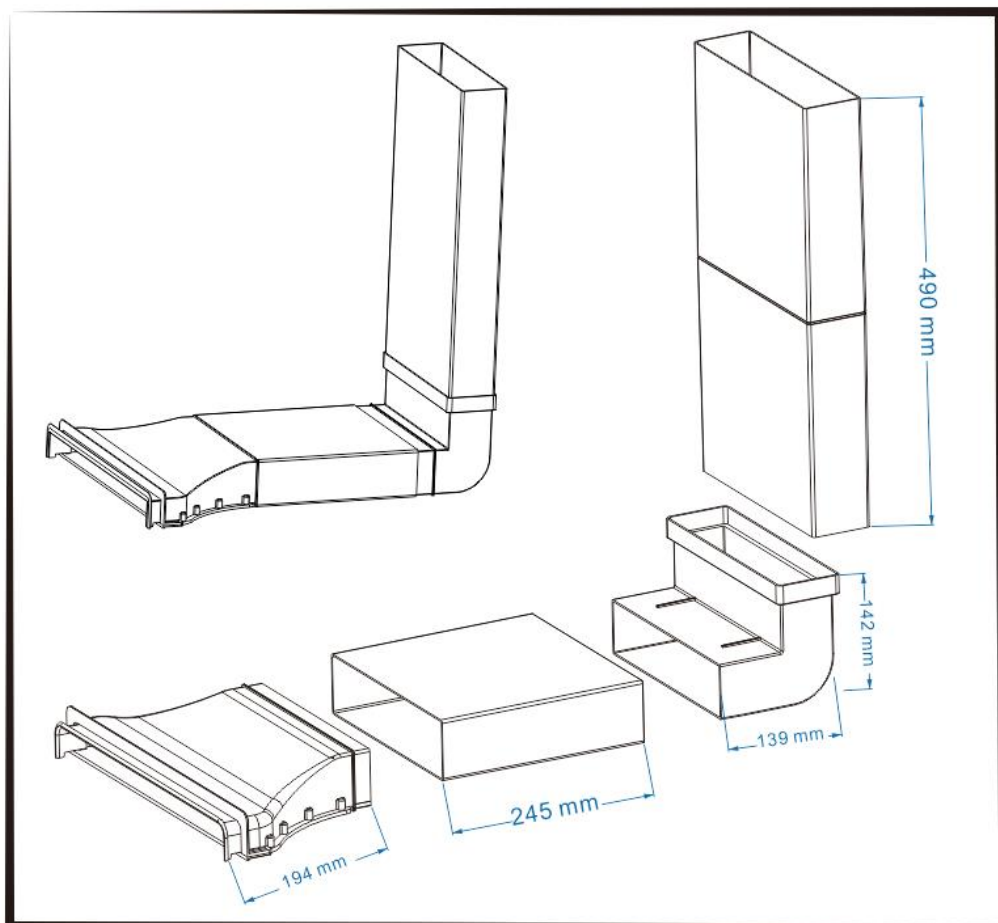

The above pipeline accessories are optional, please consult relevant sales channels for details.

Caution! Before drilling it is extremely important to check the wall for hidden pipes, electrical cables etc using an appropriate detection device.

Warning: Good ventilation is required around the appliance for easier dissipation of heat and low power consumption. Sufficient clearance is required around the appliance. The minimum base unit width that this appliance can be installed into is 80cm wide.

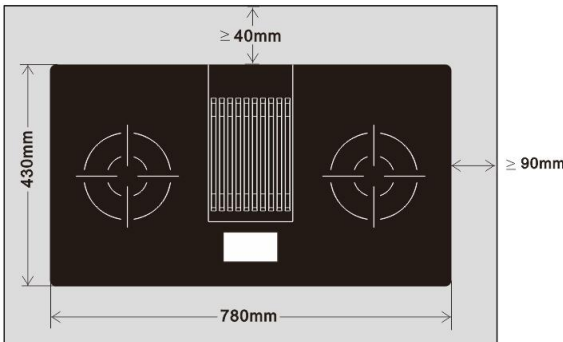
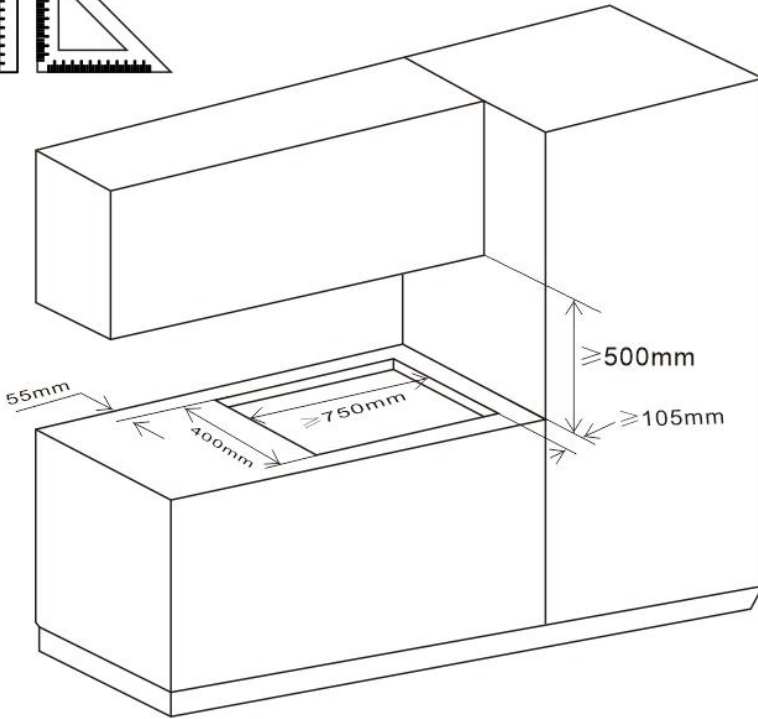
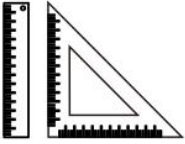

Cut out the work surface according to the sizes shown in the drawing.

For the purpose of installation and use, a minimum of 5 cm space shall be preserved around the hole.

Be sure the thickness of the work surface is at least 30 mm. Please select heat-resistant work surface material to avoid larger deformation caused by the heat radiation from the hotplate. As shown below:

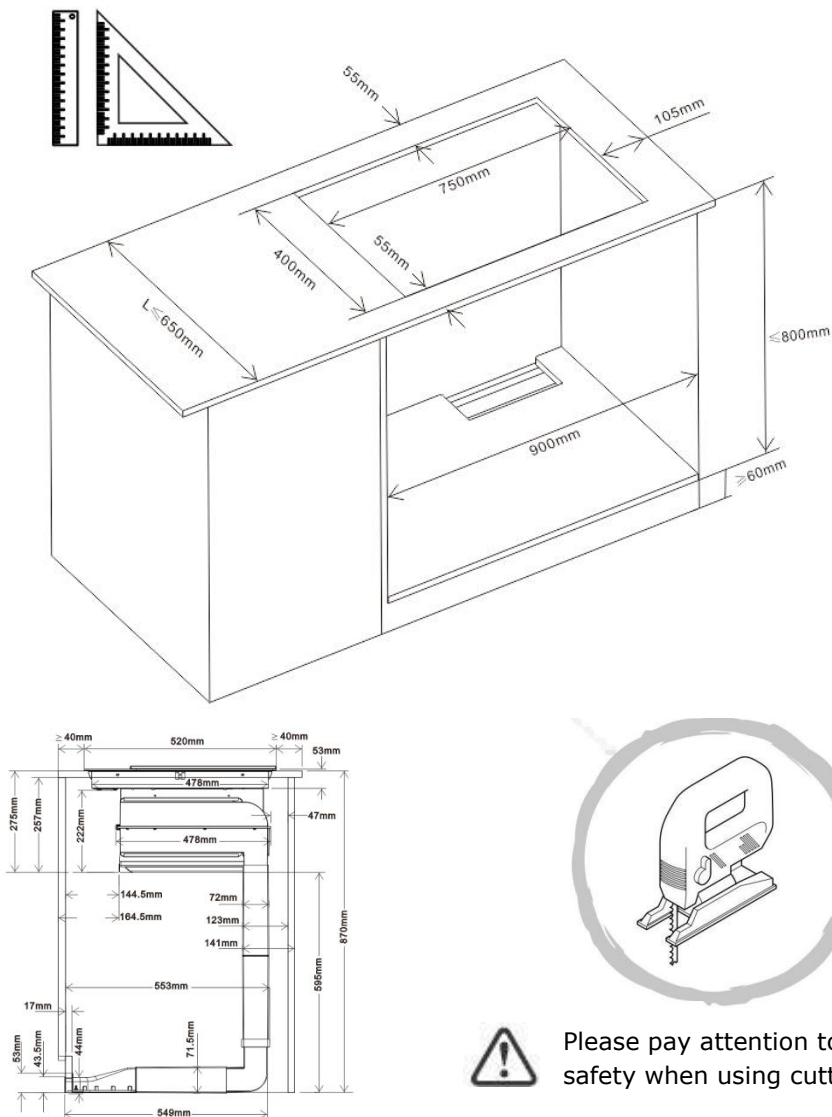

Please pay attention to personnel safety when using cutting tools!

Before you install the hob, make sure that

- The work surface is square and level, and no structural members interfere with space requirements
- The work surface is made of a heat-resistant material
- If the hob is installed above an oven, the oven has a built-in cooling fan
- The installation will comply with all clearance requirements and applicable standards and regulations
- A suitable isolating switch providing full disconnection from the mains power supply is incorporated in the permanent wiring, mounted and positioned to comply with the local wiring rules and regulations.
The isolating switch must be of an approved type and provide a 3 mm air gap contact separation in all poles (or in all active [phase] conductors if the local wiring rules allow for this variation of the requirements)
- The isolating switch will be easily accessible to the customer with the hob installed
- You consult local building authorities and by-laws if in doubt regarding installation
- You use heat-resistant and easy-to-clean finishes (such as ceramic tiles) for the wall surfaces surrounding the hob.

When you have installed the hob, make sure that

- The power supply cable is not accessible through cupboard doors or drawers
- There is adequate flow of fresh air from outside the cabinetry to the base of the hob
- If the hob is installed above a drawer or cupboard space, a thermal protection barrier is installed below the base of the hob to avoid touching the bottom of the hob.
- The isolating switch is easily accessible by the customer

Before locating the fixing brackets

The unit should be placed on a stable, smooth surface (use the packaging). Do not apply force onto the controls protruding from the hob.

Locating the fixing brackets

- The unit should be placed on a stable, smooth surface (use the packaging). Do not apply force onto the controls protruding from the hob.

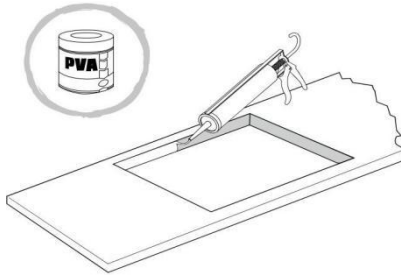

Seal the cut edge of the worktop using silicone sealant or PVA adhesive.

IMPORTANT: ensure that either product is fully cured as per the manufacturers instructions before you commence installation of the hob. This hob **MUST NOT** be sealed into the worktop.

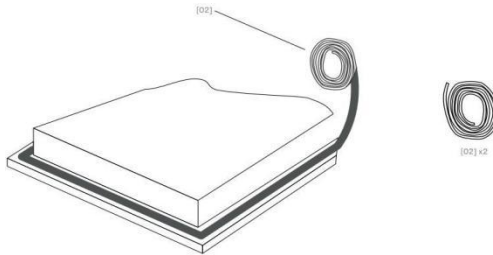

Stretch out and stick the supplied tape along the underside edge of the hob, ensuring the ends overlap. Trim off any excess tape and dispose of it.

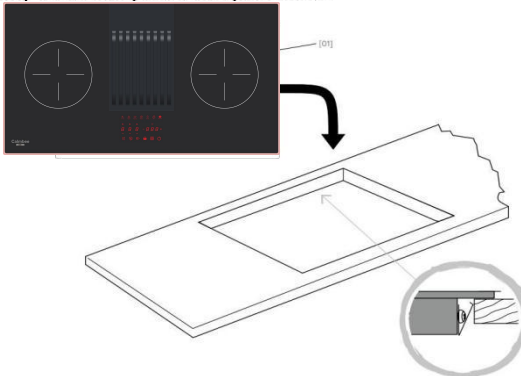

Once the worktop edge has cured, and the tape is fitted, position the hob into the cutout in the worktop. Apply gentle downwards pressure onto the hob to push it into the worktop ensuring a good seal around the outer edge.

Cautions

This appliance must be installed by the qualified technical person in compliance with the instructions provided.

The manufacturer declines all responsibility for improper installation, which may harm persons and animals and cause damage.

- This appliance must not be installed directly above a dishwasher, fridge, freezer, washing machine, oven or clothes dryer, as the humidity may damage the hob electronics.
- Do not attempt to dismantle the appliance, there are no user serviceable parts inside.
- At the end of its life, the appliance should not be disposed of in household waste; contact your local authority for guidance.
- Check the package and make sure you have all of the parts listed.
- Decide an appropriate location for your product.

Important: If the room contains a fuel burning appliance, such as a gas, or oil fired, central heating boiler, which is not of the 'Balanced Flue' type, you should make sure that there is adequate air inlet into the room at all times so that fumes from the boiler are not drawn back into the room by the Cooker Hood.

Caution:

- This hob must be connected to the mains power supply only by the suitable qualified person.
- Before connecting the hob to the mains power supply, check that:
 1. The domestic wiring system is suitable for the power drawn by the hob.
 2. The voltage corresponds to the value given in the rating plate.
 3. The power supply cable sections can withstand the load specified on the rating plate.
- To connect the hob to the mains power supply, do not use adapters, reducers, or branching devices, as they can cause overheating and fire.
- The power supply cable must not touch any hot parts and must be positioned so that its temperature will not exceed 75°C at any point.

- The work surface is square and level, and no structural members interfere with space requirements.
- The work surface is made of a heat-resistant material.
- If the hob is installed above an oven, the oven has a built-in cooling fan.
- The installation will comply with all clearance requirements and applicable standards and regulations.
- A suitable isolating switch providing full disconnection from the mains power supply is incorporated in the permanent wiring, mounted and positioned to comply with the local wiring rules and regulations. The isolating switch must be of an approved type and provide a 3 mm air gap contact separation in all poles (or in all active [phase] conductors if the local wiring rules allow for this variation of the requirements).
- The isolating switch will be easily accessible to the customer with the hob installed.
- You consult local building authorities and by-laws if in doubt regarding installation.
- You use heat-resistant and easy-to-clean finishes (such as ceramic tiles) for the wall surfaces surrounding the hob. When you have installed the hob, make sure that:
 - The power supply cable is not accessible through cupboard doors or drawers.
 - There is adequate flow of fresh air from outside the cabinetry to the base of the hob.
 - If the hob is installed above a drawer or cupboard space, a thermal protection barrier is installed below the base of the hob.
 - The isolating switch is easily accessible by the customer.
 - The hob should be fixed into the worktop using the fixing brackets and sealing tape supplied with the appliance. Do not use silicone sealant or PVA to secure the hob. Doing so will prevent an engineer removing the appliance to facilitate a repair.

Connecting the hob to the mains power supply



This hob must be connected to the main power supply by the suitable qualified person. Before connecting the hob to the mains power supply, check that:

1. the domestic wiring system is suitable for the power drawn by the hob.
 2. the voltage corresponds to the value given in the rating plate
 3. the power supply cable sections can withstand the load specified on the rating plate.
- To connect the hob to the mains power supply, do not use adapters, reducers, or branching devices, as they can cause overheating and fire.
The power supply cable must not touch any hot parts and must be positioned so that its temperature will not exceed 75°C at any point.



Check with an electrician whether the domestic wiring system is suitable without alterations. Any alterations must only be made by a qualified electrician.

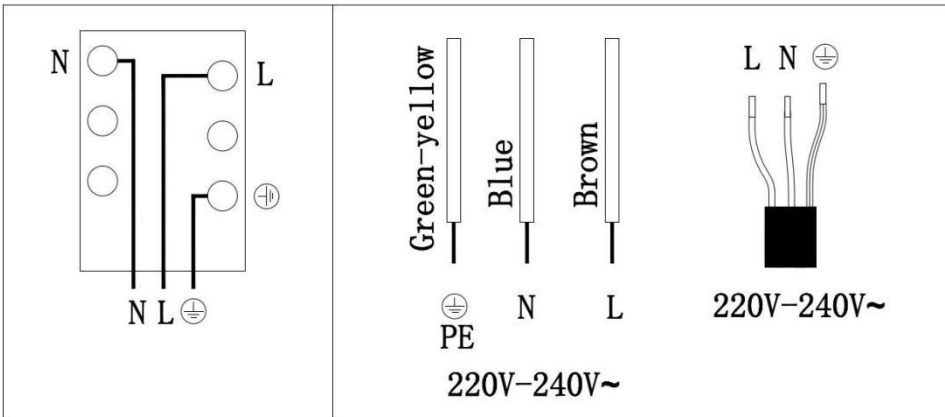

- If the power cable is damaged or to be replaced, the operation must be carried out by the after-sale agent with dedicated tools to avoid any accidents.
- If the appliance is being connected directly to the main power supply, the unipolar circuit-breaker must be installed with a minimum opening of 3mm between contacts.
- The installer must ensure that the correct electrical connection has been made and that it is compliant with safety regulations.
- The cable must not be bent or compressed.
- The cable must be checked regularly and replaced by authorized technicians only.

This appliance requires a 40 Amp Miniature Circuit Breaker.

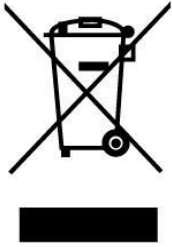

DISPOSAL: Do not dispose this product as unsorted municipal waste. Collection of such waste separately for special treatment is necessary.

This appliance is labeled in compliance with European directive 2011/65/EU for Waste Electrical and Electronic Equipment (WEEE). By ensuring that this appliance is disposed of correctly, you will help prevent any possible damage to the environment and to human health, which might otherwise be caused if it were disposed of in the wrong way.

The symbol on the product indicates that it may not be treated as normal household waste. It should be taken to a collection point for the recycling of electrical and electronic goods.

This appliance requires specialist waste disposal. For further information regarding the treatment, recover and recycling of this product please contact your local council, your household waste disposal service, or the shop where you purchased it.

For more detailed information about treatment, recovery and recycling of this product, please contact your local city office, your household waste disposal service or the shop where you purchased the product.

